

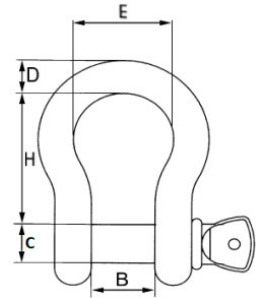

## Nagyszilárdságú sekli omega

Chei de tachelaj omega - High tensile bow shackle with screw pin

Teherbírás WLL/To	Méret	B mm	D mm	H mm	C mm	E mm	Önsúly kg
0,33	3/16"	9,65	4,8	22	6	15,3	0,040
0,50	1/4"	12	6,35	29	8	19,8	0,070
0,75	5/16"	13,5	8	32	10	21,4	0,130
1,00	3/8"	16,8	9,7	36,5	11	26,2	0,170
1,50	7/16"	19,1	11,2	43	12	29,5	0,250
2,00	1/2"	20,6	12,7	51	16	33,3	0,440
3,25	5/8"	27	16	64	19	42,9	0,790
4,75	3/4"	32	20,6	76	22	50,8	1,260
6,50	7/8"	36,6	24,6	83	25	58	1,880
8,50	1"	43	27	95	28	68,4	2,780
9,50	1 1/8"	46	31,75	108	32	74	3,870
12,00	1 1/4"	51,6	35	115	35	82,6	5,26
13,50	1 3/8"	57,2	38,1	133	38	92,2	6,940
17,00	1 1/2"	60,5	41,2	146	42	98,6	8,790
25,00	1 3/4"	73,2	57,2	178	50	127	14,990
35,00	2"	82,6	61	197	65	146	20,650
55,00	2 1/2"	105	79,5	254	70	184,2	41,050
85,00	3"	127	90	330	80	190	62,240



## Nagyszilárdságú sekli patkó

Chei de tachelaj drepte cu bolt filetata - High tensile Dee shackle with screw pin

Teherbírás WLL/To	Méret	B mm	D mm	H mm	A mm	Önsúly kg
0,33	3/16"	9,5	5	19	6	0,020
0,50	1/4"	12	6,35	25	8	0,060
0,75	5/16"	13,5	8	27	10	0,110
1,00	3/8"	16,8	9,7	31	11	0,150
1,50	7/16"	19	11,2	37	12	0,210
2,00	1/2"	20,6	12,7	41,4	16	0,370
3,25	5/8"	27	15,5	51	19	0,650
4,75	3/4"	32	20,6	62	22	1,060
6,50	7/8"	36,6	24,6	75	25	1,560
8,50	1"	43	25,4	81	28	2,230
9,50	1 1/8"	46	31,75	90	32	3,280
12,00	1 1/4"	51,6	35	94	35	4,510
13,50	1 3/8"	57,2	38,1	115	38	5,930
17,00	1 1/2"	60,5	41,1	127	42	7,890
25,00	1 3/4"	73,2	53,8	149	50	13,400
35,00	2"	82,6	50,8	171	57	18,850
55,00	2 1/2"	105	66,5	209	70	37,860
85,00	3"	127	75	230	80	56,680

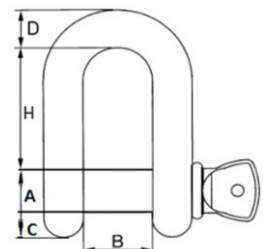



## Nagyszilárdságú sekli omega, anyás

Chei de tachelaj omega cu siguranta - High tensile bow shackle with safety bolt

Teherbírás WLL/To	Méret	B mm	D mm	H mm	A mm	E mm	Önsúly kg
0,33	3/16"	9,7	4,8	22	6,35	15,3	0,030
0,50	1/4"	11,9	6,35	29	7,85	19,8	0,070
0,75	5/16"	13,5	8	32	9,65	21,4	0,130
1,00	3/8"	16,8	9,7	36,5	11,2	26,2	0,170
1,50	7/16"	19	11,2	43	12,7	29,5	0,250
2,00	1/2"	20,6	12,7	51	16	33,3	0,440
3,25	5/8"	27	17,5	64	19,1	42,9	0,790
4,75	3/4"	32	20,6	76	22,4	50,8	1,260
6,50	7/8"	36,6	24,6	83	25,4	58	1,880
8,50	1"	43	27	95	28,7	68,4	2,780
9,50	1 1/8"	46	31,75	108	31,8	74	3,870
12,00	1 1/4"	51,6	35	115	35,1	82,6	5,260
13,50	1 3/8"	57,2	38,1	133	38,1	92,2	6,940
17,00	1 1/2"	60,5	41,2	146	41,4	98,6	8,790
25,00	1 3/4"	73,2	57,2	178	51,0	127	14,990
35,00	2"	82,6	61	197	57	146	20,650
55,00	2 1/2"	105	79,5	254	70,0	184,2	41,050
85,00	3"	127	92	330	82,5	200,2	62,240
120,00	3-1/2"	133,4	104,6	381	95,5	228,6	120,00
150,00	4"	139,7	115,8	432	108	254	153,00

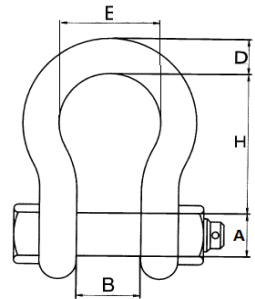

## Nagyszilárdságú sekli patkó, anyás

Chei de tachelaj drepte cu siguranta - High tensile dee shackle with safety bolt

Teherbírás WLL/To	Méret	B mm	D mm	H mm	A mm	Önsúly kg
0,50	1/4"	11,9	6,4	25	8	0,070
0,75	5/16"	13,5	8	27	9,7	0,130
1,00	3/8"	16,8	9,7	31	11,2	0,180
1,50	7/16"	19	11,2	37	12,7	0,240
2,00	1/2"	20,6	12,7	41	16,3	0,370
3,25	5/8"	27	16	51	20	0,650
4,75	3/4"	32	20,6	62	22,6	1,060
6,50	7/8"	36,6	24,6	75	25,9	1,560
8,50	1"	43	25,4	81	29,2	2,320
9,50	1 1/8"	46	31,75	90	31,8	3,280
12,00	1 1/4"	51,6	35	94	35,6	4,510
13,50	1 3/8"	57,2	38,1	115	38,9	5,930
17,00	1 1/2"	60,5	41,2	127	42,2	7,890
25,00	1 3/4"	73,2	53,8	149	51,8	13,400
35,00	2"	82,6	59,9	171	58,4	18,850
55,00	2 1/2"	105	66,8	203	71,1	37,860
85,00	3"	127	90	230	82,6	58,680

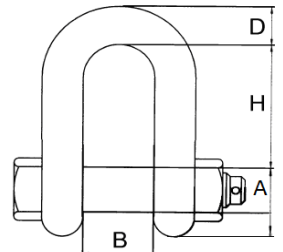



## Gyűrűs csavar DIN 580

Inel de ridicare cu filet exterior DIN 580 - DIN 580 eye bolt

Méret mm	A mm	B mm	C mm	E mm	F mm	G mm	H mm	L mm	S.W.L WLL/kg	45°kg S.W.L	Önsúly kg
M 6	20	36	20	6	8	10	36	13	90	60	0,060
M 8	20	36	20	6	8	10	36	13	140	100	0,060
M 10	25	45	25	8	10	12	45	17	230	170	0,110
M 12	30	54	30	10	12	14	53	20,5	340	240	0,170
M 14	30	54	30	10	12	14	53	20,5	500	350	0,170
M 16	35	63	35	12	14	16	62	27	700	500	0,310
M 18	35	63	35	12	14	16	62	27	930	650	0,480
M 20	40	72	40	14	16	19	71	30	1200	860	0,480
M 22	40	72	40	14	16	19	71	30	1500	1050	0,480
M 24	50	90	50	18	20	24	90	36	1800	1290	0,900
M 27	54	98	62	20	22	26	99	40	2500	1830	1,250
M 30	60	108	65	22	24	28	109	45	3200	2300	1,700
M 33	60	108	65	22	24	28	109	45	4200	3050	1,900
M 36	70	126	75	26	28	32	128	54	4600	3300	2,150
M 39	80	144	85	30	32	38	147	63	6000	4400	4,000
M 42	80	144	85	30	32	38	147	63	6300	4500	4,150
M 45	90	166	100	35	38	46	168	68	7800	5500	6,100
M 48	90	166	100	35	38	46	168	68	8600	6100	6,200
M 52	100	184	110	38	42	50	187	78	9900	7100	8,600
M 56	100	184	110	38	42	50	187	78	11500	8200	8,800
M 64	110	206	120	42	48	58	208	90	16000	11000	12,400
M 72	140	260	150	50	60	72	260	100	20000	14000	22,500
M 80	160	296	170	55	68	80	298	112	28000	20000	34,500
M 100	180	330	190	60	75	88	330	130	40000	29000	47,800

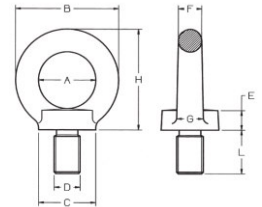

## Gyűrűs anya DIN 582

Inel de ridicare cu filet interior DIN 582 - Din 582 eye nut

Méret mm	A mm	B mm	C mm	E mm	F mm	G mm	H mm	S.W.L WLL/kg	45°kg S.W.L	Önsúly kg
M 6	20	36	20	8,5	8	10	36	90	60	0,060
M 8	20	36	20	8,5	8	10	36	140	100	0,060
M 10	25	45	25	10	10	12	45	230	170	0,100
M 12	30	54	30	11	12	14	53	340	240	0,170
M 14	30	54	30	11	12	14	53	500	350	0,210
M 16	35	63	35	13	14	16	62	700	500	0,260
M 18	35	63	35	13	14	16	62	930	650	0,240
M 20	40	72	40	16	16	19	71	1200	860	0,410
M 22	40	72	40	16	16	19	71	1500	1050	0,360
M 24	50	90	50	20	20	24	90	1800	1290	0,750
M 27	54	98	62	22	22	26	99	2500	1830	0,800
M 30	60	108	65	25	24	28	109	3200	2300	1,400
M 33	60	108	65	25	24	28	109	4200	3050	1,270
M 36	70	126	75	30	28	32	128	4600	3300	2,030
M 39	80	144	85	35	32	38	147	6000	4400	3,200
M 42	80	144	85	35	32	38	147	6300	4500	3,050
M 45	90	166	100	40	38	46	168	7800	5500	5,000
M 48	90	166	100	40	38	46	168	8600	6100	4,820
M 52	100	184	110	45	42	50	187	9900	7100	7,000
M 56	100	184	110	45	42	50	187	11500	8200	6,690
M 64	110	206	120	50	48	58	208	16000	11000	10,100
M 72	140	260	150	60	60	72	260	20000	14000	46,000

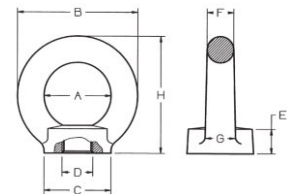



## Kötél végzáró DIN-15315

Papuc pentru cablu - Wire rope socket

Kötél átmérő mm	b mm	c mm	d mm	s mm	h1 mm	r1 mm	r2 mm	h2 mm
4 - 5	12	33	10	3	110	2,5	9,5	68
6 - 8	14	45	12	4	150	4	12,5	92
9 - 11	17	60	16	6	190	5,5	16	117
12 - 14	22	78	18	8	230	7	19	141
15 - 17	25	92	22	10	260	8,5	23	162
18 - 20	27	106	25	12	300	10	26	186

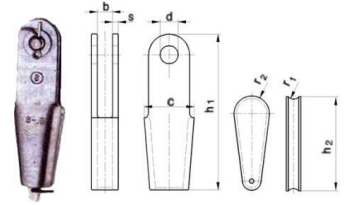

## Kötél végzáró DIN-43148

Papuc pentru cablu - Wire rope socket

Kötél átmérő mm	b mm	c mm	d mm	s mm	h1 mm	r1 mm	r2 mm	h2 mm
4 - 5	12	33	10	3	110	2,5	9,5	68
6 - 8	14	45	12	4	150	4	12,5	92
9 - 11	17	60	16	6	190	5,5	16	117
12 - 14	22	78	18	8	230	7	19	141
15 - 17	25	92	22	10	260	8,5	23	162
18 - 20	27	106	25	12	300	10	26	186

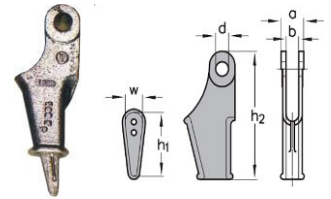

## Nehéz kötélcsív DIN 3091

Rodanta grea - Heavy duty thimble

Méret mm	A mm	B mm	C mm	A1 mm	H mm	L1 mm
8	9	15	40	14	4,5	66
10	11	17,5	50	18	6	82
12	13	20	60	21	7,5	98
14	16	23,5	70	25	9	114
16	18	26	80	28	10,5	130
18	20	28,5	90	31	12	145
20	22	31	100	35	13,5	161
22	24	33,5	110	38	15	177
24	26	36	120	41	16,5	193
26	29	39,5	130	44	18	209
28	31	42	140	47	20	224
32	35	47	160	53	23	256
36	40	53	180	59	26	288
40	44	58	200	65	29	320

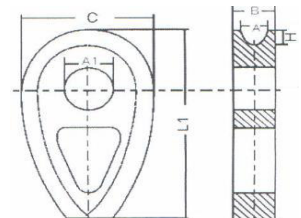





## Kötélszív DIN 6899 FORM - A

Rodanta - Thimble

Méret mm	Méretek				
	C mm	A mm	B mm	S mm	kg/db
2,5	3	10	21,5	0,5	0,0015
3,5	4	12	26,5	0,75	0,0035
4	5	13	28,5	0,75	0,0043
5	6	14	30	1	0,0058
7	8	16	35	1,25	0,0101
9	10	20	43	1,25	0,0198
11	12	24	51,5	1,5	0,0370
13	14	28	61,0	1,8	0,0725
15	16	32	69,5	2	0,0833
16	19	35	78	2,5	0,1790
18	20	40	86,5	2,5	0,2700
20	22	44	95	2,5	0,3550

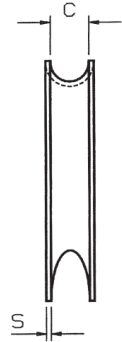
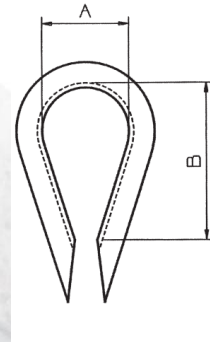

## Kötélszív DIN 6899 FORM - B

Rodanta - Thimble

Méret mm	Méretek				
	C mm	A mm	B mm	S mm	kg/db
22	24	56	90	3	0,047
24	26	62	99	4	0,590
26	28	70	112	5	0,800
28	30	75	120	5	1,100
30	32	80	128	5	1,230
32	34	95	152	5	1,560
34	36	100	160	4,5	1,760
36	36	110	176	4,5	1,920
38	40	115	184	6	2,920
40	42	120	192	6	3,200
42	45	150	240	6	3,640
46	48	120	220	6	5,750
48	50	120	240	7	6,200
52	54	145	275	8	6,900
56	58	145	305	9	8,500
60	65	150	345	10	7,060
72	75	200	350	15	12,000
87	90	210	370	18	26,000
97	100	220	380	20	30,500

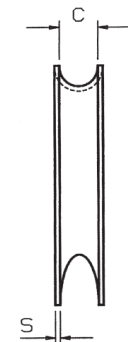
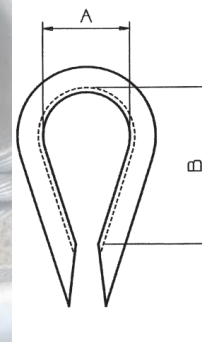

## Rozsdamentes kötélszív AISI 316

Rodanta INOX - Stainless steel thimble

Méret mm	Méretek				
	A mm	B mm	C mm	S mm	kg/db
2	2	7	10	0,7	0,003
3	3	10	16	1	0,006
4	4	11	17	1	0,008
5	5	13	20	1,2	0,010
6	6	16	25	1,2	0,010
8	8	20	32	1,5	0,020
10	10	26	40	1,5	0,030
12	12	28	45	1,5	0,040
14	14	34	56	2	0,800
16	16	37	62	2	0,120

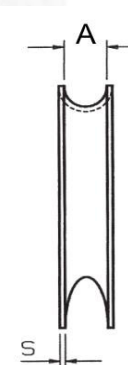
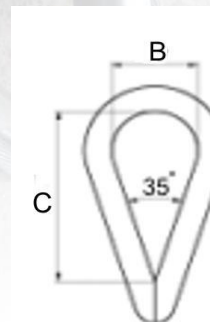



## Kereskedelmi kötélbilincs DIN 741

Brida comerciala - Wire rope clips (commercial type)

Méret	A mm	B mm	C mm	D mm	I mm	L mm	L1 mm	Önsúly kg
3	21	10	10	M 4	9	20	12	0,010
5	23	11	10	M 5	11	24	13	0,020
6	26	12	11	M 5	13	28	15	0,020
8	30	14	15	M 6	16	34	19	0,020
10	34	20	19	M 8	20	42	22	0,060
12	41	25	21	M 10	24	55	30	0,110
14	46	25	25	M 10	27	57	30	0,120
16	52	28	28	M 12	30	63	33	0,150
19	58	32	34	M 12	34	75	38	0,230
22	64	35	35	M 14	38	85	44	0,270
26	68	38	38	M 14	42	95	45	0,300
30	80	40	45	M 16	50	110	50	0,500
32	80	40	45	M 16	50	118	50	0,650
34	88	45	52	M 16	54	120	55	0,680
40	95	48	58	M 16	60	140	60	0,860
45	115	49	65	M 18	70	165	65	1,480
50	115	51	67	M 18	70	170	67	1,950

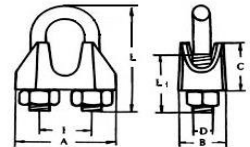

A DIN 741 kötélbilincs segítségével a sodronykötelek bontható fülecselése oldható meg.

## Minősített kötélbilincs DIN 1142

Brida industrialia - Wire rope clips (industrial type)

Méret mm	A mm	B mm	C mm	D mm	I mm	L mm	L1 mm	Önsúly kg
5	25	13	13	M5	12	25	13	0,020
6,5	30	16	14	M6	14	32	17	0,040
8	39	20	18	M8	18	41	20	0,082
10	40	20	21	M8	20	46	24	0,092
13	55	28	29	M12	27	64	30	0,275
16	64	32	35	M14	32	76	35	0,430
19	68	32	40	M14	36	83	36	0,490
22	74	34	44	M16	40	96	40	0,680
26	84	38	51	M20	46	111	50	1,170
30	95	41	59	M20	54	127	55	1,400
34	105	45	67	M22	60	141	60	2,130
40	117	49	77	M24	68	159	65	2,680

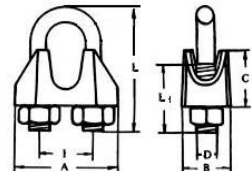

A DIN 1142 kötélbilincs segítségével a sodronykötelek bontható fülecselése oldható meg.

## Rozsdamentes kötélbilincs AISI 316

Brida de inox - Stainless steel wire rope clips (commercial type)

Méret	A mm	B mm	C mm	D mm	E mm	L mm	H mm	Önsúly kg
3-4	22	14	8	4	7	22	12	0,010
5	24	16	9	5	8	24	15	0,020
6	30	18	11	6	10	33	18	0,030
8	33	20	12	6	10	35	20	0,040
10	37	22	14	8	13	43	22	0,070
12	45	25	16	10	17	54	30	0,120
14	46	27	18	10	17	54	30	0,150
16	53	30	20	10	17	65	30	0,200
18	55	31,5	21	12	19	80	35	0,240
19-20	58	33	22	12	19	80	35	0,270

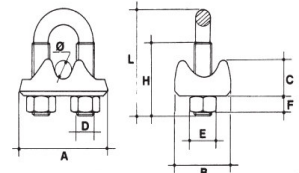



## Szimplex bilincs

Brida simplex - Simplex wire rope clips

Méret mm	A mm	B mm	C mm	D mm	E mm	F mm	G mm	Önsúly kg
2	17,5	12	5	M4	7,5	1	1	0,002
3	17,5	15	6,5	M4	10	1,5	1,5	0,002
4	22	18	7,5	M5	12	1,5	1,5	0,004
5	24	20	8,5	M5	14	1,5	1,5	0,004
6	30	23	10	M6	17	1,5	1,5	0,005
8	36	30	14	M8	22	2	2	0,050
10	42	34	16	M10	25	3	2	0,090

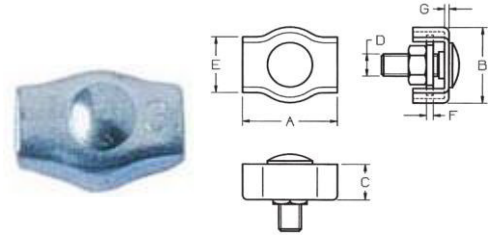

## Duplex bilincs

Brida duplex - Duplex wire rope clips

Méret mm	D mm	A mm	B mm	C mm	E mm	G mm	I mm	Önsúly kg
2	M4	38	12	5	7,5	1	20,5	0,010
3	M4	38	15	6,5	10	1,5	20,5	0,015
4	M5	47	18	7,5	12	1,5	25	0,025
5	M5	51	20	8,5	14	1,5	27	0,035
6	M6	63	23	10	17	1,5	33	0,050
8	M8	76	30	14	22	2	42	0,100
10	M10	88	34	16	25	3	46	0,180

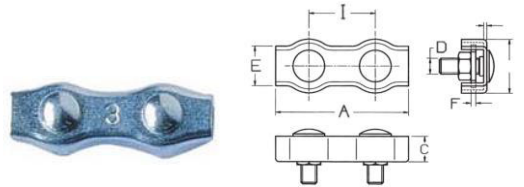

## Tűzoltó karabiner DIN 5299

Carabina de pompier - Snap hook

Méret mm	A mm	B mm	C mm	D mm	L mm	S.W.L.	Önsúly kg
4X40	7	14	6	4	40	30	0,010
5X50	8	15	7	5	50	100	0,020
6X60	9	17	8	6	60	120	0,020
7X70	10	19	8	7	70	180	0,040
8X80	12	23	10	8	80	230	0,070
9X90	12	24	10	9	90	250	0,090
10X100	15	29	11	10	100	350	0,130
11X120	18	36	16	11	120	380	0,190
12X140	20	40	19	12	140	400	0,200
13X160	22	54	23	13	160	410	0,360

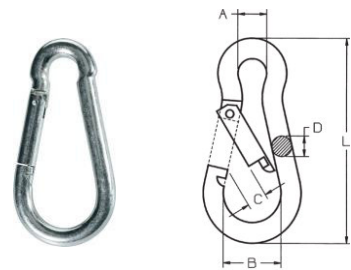

## Menetes karabiner

Carabina cu surub - Snap hook with safety screw

Méret mm	A mm	B mm	C mm	D mm	L mm	S.W.L.	Önsúly kg
60X6	7	6	6	10	60	130	0,028
70X7	8	7	7	11	70	180	0,043
80X8	9	8	8	13	80	230	0,066
9X90	10	9	8	13	90	250	0,092
100X10	11	10	10	16	100	350	0,129
120X11	12	11	15	19	120	450	0,186
140X12	14	12	17	20	140	510	0,256
160X13	16	13	25	22	160	600	0,354
180X14	16	14	39	22	180	650	0,486

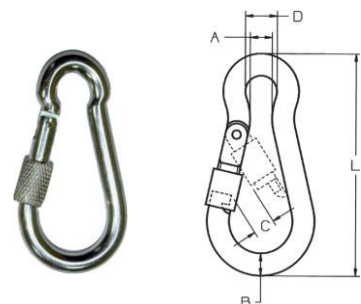





### Rövid szemű kereskedelmi lánc

Lant comercial cu za scurta - Commercial chain with short links

Méret Ø mm	T mm	P mm	Súly kg/100m	Teherbírás kg
3	16	11,4	16,5	45
4	19	15,2	30	80
5	21	19	50	125
6	24	22,8	73	160
8	32	30,4	130	320

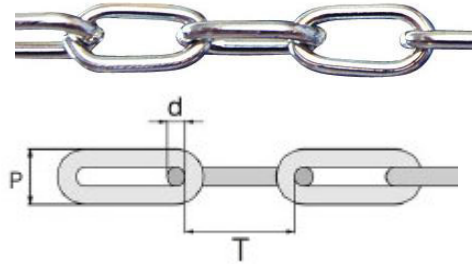

### Hosszú szemű kereskedelmi lánc

Lant comercial cu za lunga - Commercial type chain, long links

Méret Ø mm	T mm	P mm	Súly kg/100m	Teherbírás kg
3	26	11,4	15	45
3,5	28	13,3	20	63
4	32	15,2	27	80
4,5	34	17,1	35	100
5	35	19	43	125
6	42	22,8	63	160
7	49	26,6	86	250
8	52	30,4	110	320
10	65	38	175	500

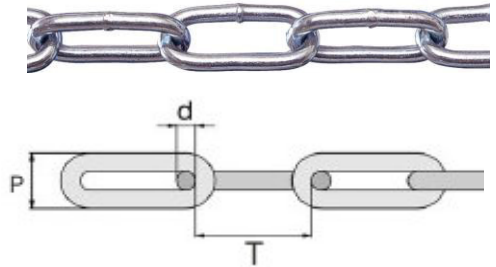

### Mezőgazdasági feszítő

Intinzator agricol - Wire-ties for agriculture

Méret	A mm	B mm	E mm	L mm	Önsúly kg
2	26	6	5,5	92	0,090

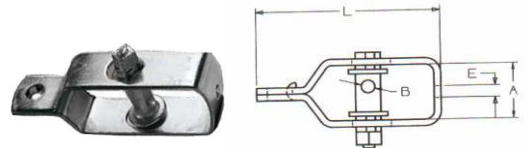

### Fonatolt PP (polipropilén) kötél

Franghie polipropilena - Polypropylene ropes

Méret Ø mm	4	6	8	10	12	14	16	18	20
Súly gr/m	7,5	17	30	47	67	88	115	140	200
Szakítószilárdság (kg)	80	180	300	600	800	1200	1400	1800	2000







## Kötélfeszítő sekli-sekli, zárt DIN 1478

Intinzator furca-furca DIN 1478 - Turnbuckle Jaw-Jaw DIN 1478

Méret Ø	A mm	B mm	C mm	D mm	L1 mm	L2 mm	Csavar mm	Teherbírás kg	Önsúly kg
M 6	110	87	60	8	174	274	6 x 25	230	0,150
M 8	110	104	70	10	208	304	8 x 35	440	0,260
M 10	125	124	80	12	248	357	8 x 35	440	0,450
M 12	125	145	90	16	290	395	10 x 40	600	0,660
M 16	170	170	100	20	340	483	12 x 50	800	1,510
M 20	200	184	110	24	368	536	16 x 60	1650	2,930
M 24	255	215	125	30	345	646	20 x 75	2600	5,000
M 30	255	252	140	36	504	711	24 x 85	3400	9,970
M 36	295	300	170	45	600	835	30 x 115	4800	14,800

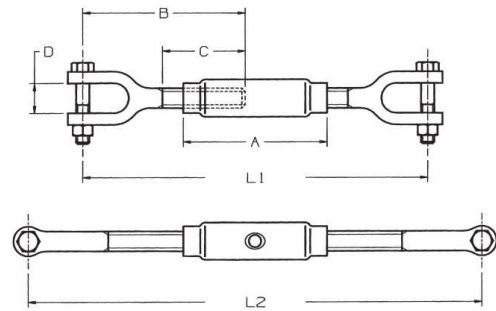

## Kötélfeszítő szemes-horgos DIN 1480

Intinzator ochi-carlig DIN 1480 - Turnbuckle DIN 1480 eye-hook

Méret Ø	A mm	B mm	C mm	D mm	E mm	F mm	G mm	H mm	L1 mm	L2 mm	S.W.L. kg	Önsúly kg
M 6	12	110	74	50	10	76	50	8,5	155	235	75	0,090
M 8	15	110	80	52	11	89	52	10	160	240	165	0,140
M 10	18	125	97	60	14	103	62	12	200	270	235	0,280
M 12	21	125	106	67	17	121	65	16	205	270	320	0,410
M 14	23	140	126	83	18	144	82	16	245	330	420	0,570
M 16	27	170	160	97	23	172	105	16,5	285	390	530	0,960
M 20	34	200	190	116	25	185	110	17,5	315	425	730	1,540
M 22	36	220	200	120	30	216	125	23	330	450	1120	2,130
M 24	39	255	210	125	34	225	135	23	405	570	1550	2,840
M 27	45	255	236	150	34	250	135	29	445	585	1870	3,890
M 30	45	255	240	150	38	250	145	29	450	595	2240	4,150
M 33	45	255	242	150	39	250	145	29	451	596	2850	5,880
M 36	55	295	276	160	48	284	170	30	516	676	3530	7,530
M 39	63	330	276	165	48	288	170	30	519	700	4150	9,380

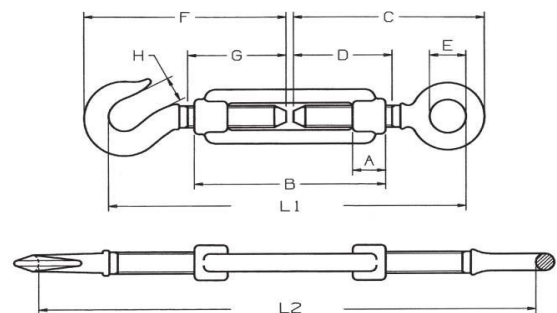



## Kötélfeszítő szemes-szemes DIN 1480

Intinzator ochi-ochi DIN 1480 - Turnbuckle DIN 1480 eye-eye

Méret Ø	A mm	B mm	C mm	D mm	E mm	F mm	L1 mm	L2 mm	S.W.L. kg	Önsúly kg
M 6	12	110	74	50	10	4	155	225	225	0,080
M 8	15	110	80	52	11	5	160	230	410	0,140
M 10	18	125	97	60	14	6,5	200	270	650	0,250
M 12	21	125	106	67	17	8	205	270	930	0,370
M 14	23	140	126	83	18	8,5	240	325	1320	0,510
M 16	27	170	160	97	23	13	280	380	1770	0,950
M 20	34	200	190	116	25	14	310	410	2700	1,480
M 22	36	220	200	120	30	16	325	430	3300	2,060
M 24	39	255	210	125	34	17	400	565	3920	2,760
M 27	45	255	236	150	34	18,5	445	586	4950	3,910
M 30	45	255	240	150	38	19,5	451	595	6250	4,050
M 33	45	255	242	150	39	21	452	607	7560	5,750
M 36	55	295	276	160	48	27	510	673	9100	7,250
M 39	63	330	276	165	48	28	511	690	10600	9,360
M 42	63	330	320	180	55	40	575	754	12500	13,960
M 45	78	355	322	175	55	40	590	755	14400	19,100
M 48	78	355	322	180	55	40	590	755	16500	19,300
M 50	78	355	322	180	55	40	590	755	18100	20,600
M 52	78	355	322	180	55	40	590	755	18100	28,840

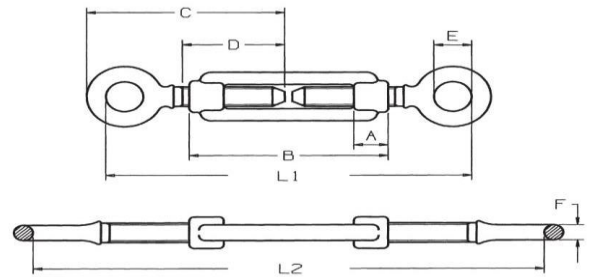

## Kereskedelmi kötőfeszítő szemes-horgos

Intinzator comercial ochi-carlig - Commercial type turnbuckle eye-hook

Méret Ø	A mm	B mm	C mm	D mm	E mm	F mm	G mm	H mm	L1 mm	L2 mm	S.W.L. kg	Önsúly kg
M 5	9	79	59	40	8	62	40	6	120	170	50	0,050
M 6	10	88	74	50	10	76	50	8,5	143	205	75	0,060
M 8	12	110	80	52	11	89	52	10	162	237	165	0,120
M 10	15	130	97	60	14	103	62	12	196	277	235	0,240
M 12	18	140	106	67	17	121	65	16	223	310	320	0,380
M 14	20	170	126	83	18	144	82	16	262	378	420	0,560
M 16	22,5	190	160	97	23	172	105	16,5	296	420	530	0,940
M 18	27	200	178	112	25	183	110	17	326	455	630	1,350
M 20	30	220	190	116	25	185	110	17,5	342	475	730	1,480
M 24	39	255	210	125	34	225	135	23	405	570	1550	2,840

